

### FEATURES

- Dual axis accelerometer on a single IC chip
- 5 mm  $\times$  5 mm  $\times$  2 mm LCC package
- 1 mg resolution at 60 Hz
- Low power: 700  $\mu$ A at  $V_s = 5$  V (typical)
- High zero  $g$  bias stability
- High sensitivity accuracy
- Pulse width modulated digital outputs
- X and Y axes aligned to within  $0.1^\circ$  (typical)
- BW adjustment with a single capacitor
- Single-supply operation
- 3500  $g$  shock survival

### APPLICATIONS

- Automotive tilt alarms
- Data projectors
- Navigation
- Platform stabilization/leveling
- Alarms and motion detectors
- High accuracy, 2-axis tilt sensing

### GENERAL DESCRIPTION

The ADXL213 is a low cost, low power, complete dual axis accelerometer with signal conditioned, duty cycle modulated outputs, all on a single monolithic IC. The ADXL213 measures acceleration with a full-scale range of  $\pm 1.2 g$  (typical). The ADXL213 can measure both dynamic acceleration (e.g., vibration) and static acceleration (e.g., gravity).

The outputs are digital signals whose duty cycles (ratio of pulse width to period) are proportional to acceleration ( $30\%/g$ ). The duty cycle outputs can be directly measured by a microcontroller without an A/D converter or glue logic.

Innovative design techniques are used to ensure high zero  $g$  bias stability (typically better than  $0.25 \text{ mg}/^\circ\text{C}$ ), as well as tight sensitivity stability (typically better than  $50 \text{ ppm}/^\circ\text{C}$ ).

The typical noise floor is  $160 \mu\text{g}/\sqrt{\text{Hz}}$ , allowing signals below 1 mg ( $0.06^\circ$  of inclination) to be resolved in tilt sensing applications using narrow bandwidths ( $< 60 \text{ Hz}$ ).

The user selects the bandwidth of the accelerometer using capacitors  $C_x$  and  $C_y$  at the  $X_{\text{FILT}}$  and  $Y_{\text{FILT}}$  pins. Bandwidths of 0.5 Hz to 250 Hz may be selected to suit the application.

The ADXL213 is available in a 5 mm  $\times$  5 mm  $\times$  2 mm, 8-pad hermetic LCC package.

### FUNCTIONAL BLOCK DIAGRAM

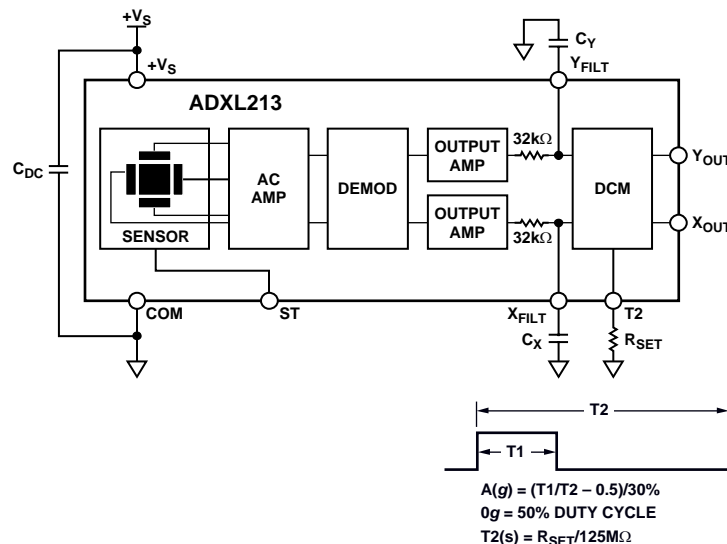

Figure 1.

### Rev. 0

Information furnished by Analog Devices is believed to be accurate and reliable. However, no responsibility is assumed by Analog Devices for its use, nor for any infringements of patents or other rights of third parties that may result from its use. Specifications subject to change without notice. No license is granted by implication or otherwise under any patent or patent rights of Analog Devices. Trademarks and registered trademarks are the property of their respective owners.

## TABLE OF CONTENTS

Specifications.....	3	Design Trade-Offs for Selecting Filter Characteristics: The Noise/BW Trade-Off.....	9
Absolute Maximum Ratings.....	4	Using the ADXL213 with Operating Voltages Other than 5 V.....	10
Typical Performance Characteristics .....	5	Using the ADXL213 as a Dual-Axis Tilt Sensor.....	10
Theory of Operation .....	8	Pin Configurations and Functional Descriptions .....	11
Performance .....	8	Outline Dimensions .....	12
Applications.....	9	ESD Caution.....	12
Power Supply Decoupling .....	9	Ordering Guide .....	12
Setting the Bandwidth Using $C_x$ and $C_y$ .....	9		
Self Test .....	9		

## REVISION HISTORY

Revision 0: Initial Version

## SPECIFICATIONS

$T_A = -40^{\circ}\text{C}$  to  $+85^{\circ}\text{C}$ ,  $V_S = 5\text{ V}$ ,  $C_X = C_Y = 0.1\ \mu\text{F}$ , Acceleration =  $0\text{ g}$ , unless otherwise noted. All minimum and maximum specifications are guaranteed. Typical specifications are not guaranteed.

**Table 1.**

Parameter	Conditions	Min	Typ	Max	Unit
SENSOR INPUT	Each axis				
Measurement Range <sup>1</sup>			$\pm 1.2$		<i>g</i>
Nonlinearity	% of full scale		$\pm 0.5$		%
Package Alignment Error			$\pm 1$		Degrees
Alignment Error	X sensor to Y sensor		$\pm 0.1$		Degrees
Cross Axis Sensitivity			$\pm 2$		%
SENSITIVITY (Ratiometric) <sup>2</sup>	Each axis				
Sensitivity at $X_{OUT}$ , $Y_{OUT}$	$V_S = 5\text{ V}$	27	30	33	%/ <i>g</i>
Sensitivity Change due to Temperature <sup>3</sup>	$V_S = 5\text{ V}$		$\pm 0.3$		%
ZERO <i>g</i> BIAS LEVEL (Ratiometric)	Each axis				
0 <i>g</i> Voltage at $X_{OUT}$ , $Y_{OUT}$	$V_S = 5\text{ V}$		$\pm 50$		%
Initial 0 <i>g</i> Output Deviation from Ideal	$V_S = 5\text{ V}$ , $25^{\circ}\text{C}$		$\pm 2$		%
0 <i>g</i> Offset vs. Temperature			$\pm 0.25$		<i>mg</i> / $^{\circ}\text{C}$
NOISE PERFORMANCE					
Noise Density	@ $25^{\circ}\text{C}$		160		$\mu\text{g}/\sqrt{\text{Hz}}$ rms
FREQUENCY RESPONSE <sup>4</sup>					
$C_X$ , $C_Y$ Range <sup>5</sup>		0.002		4.7	$\mu\text{F}$
$R_{\text{FILT}}$ Tolerance		22	32	42	$\text{k}\Omega$
Sensor Resonant Frequency			5.5		$\text{kHz}$
SELF TEST <sup>6</sup>					
Logic Input Low				1	<i>V</i>
Logic Input High		4			<i>V</i>
ST Input Resistance to Ground		30	50		$\text{k}\Omega$
Output Change at $X_{OUT}$ , $Y_{OUT}$	Self test 0 to 1		23		%
PWM Output					
$F_{\text{SET}}$	$R_{\text{SET}} = 125\ \text{k}\Omega$		1		$\text{kHz}$
T2 Drift versus Temperature			$\pm 0.3$		%
POWER SUPPLY					
Operating Voltage Range		3		6	<i>V</i>
Quiescent Supply Current			0.7	1.1	<i>mA</i>
Turn-On Time <sup>7</sup>			20		<i>ms</i>

<sup>1</sup> Guaranteed by measurement of initial offset and sensitivity.

<sup>2</sup> Sensitivity varies with  $V_S$ . At  $V_S = 3\text{ V}$ , sensitivity is typically  $28\%/g$ .

<sup>3</sup> Defined as the output change from ambient-to-maximum temperature or ambient-to-minimum temperature.

<sup>4</sup> Actual frequency response controlled by user-supplied external capacitor ( $C_X$ ,  $C_Y$ ).

<sup>5</sup> Bandwidth =  $1/(2 \times \pi \times 32\ \text{k}\Omega \times C)$ . For  $C_X$ ,  $C_Y = 0.002\ \mu\text{F}$ , Bandwidth =  $2500\text{ Hz}$ . For  $C_X$ ,  $C_Y = 4.7\ \mu\text{F}$ , Bandwidth =  $1\text{ Hz}$ . Minimum/maximum values are not tested.

<sup>6</sup> Self-test response changes with  $V_S$ . At  $V_S = 3\text{ V}$ , self-test output is typically  $8\%$ .

<sup>7</sup> Larger values of  $C_X$ ,  $C_Y$  increase turn-on time. Turn-on time is approximately  $160 \times C_X$  or  $C_Y + 4\text{ ms}$ , where  $C_X$ ,  $C_Y$  are in  $\mu\text{F}$ .

## ABSOLUTE MAXIMUM RATINGS

Table 2. ADXL213 Stress Ratings

Parameter	Rating
Acceleration (Any Axis, Unpowered)	3,500 g
Acceleration (Any Axis, Powered)	3,500 g
Drop Test (Concrete Surface)	1.2 m
V <sub>s</sub>	-0.3 V to +7.0 V
All Other Pins	(COM - 0.3 V) to (V <sub>s</sub> + 0.3 V)
Output Short-Circuit Duration (Any Pin to Common)	Indefinite
Operating Temperature Range	-55°C to +125°C
Storage Temperature	-65°C to +150°C

Table 3. Package Characteristics

Package Type	θ <sub>JA</sub>	θ <sub>JC</sub>	Device Weight
8-Lead CLCC	120°C/W	20°C/W	<1.0 gram

Stresses above those listed under Absolute Maximum Ratings may cause permanent damage to the device. This is a stress rating only; functional operation of the device at these or any other conditions above those indicated in the operational section of this specification is not implied. Exposure to absolute maximum rating conditions for extended periods may affect device reliability.

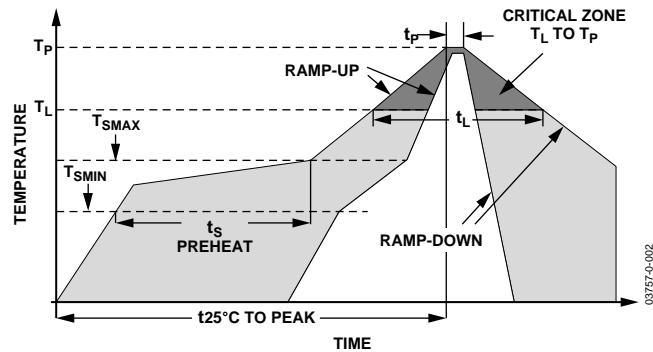

Profile Feature	Condition	
	Sn63/Pb37	Pb Free
Average Ramp Rate (T <sub>L</sub> to T <sub>P</sub> )	3°C/second max	
Preheat		
• Minimum Temperature (T <sub>SMIN</sub> )	100°C	150°C
• Minimum Temperature (T <sub>SMAX</sub> )	150°C	200°C
• Time (T <sub>SMIN</sub> to T <sub>SMAX</sub> ) (t <sub>S</sub> )	60-120 seconds	60-150 seconds
T <sub>SMAX</sub> to T <sub>L</sub>		
• Ramp-Up Rate	3°C/second	
Time Maintained above Liquidous (T <sub>L</sub> )		
• Liquidous Temperature (T <sub>L</sub> )	183°C	217°C
• Time (t <sub>L</sub> )	60-150 seconds	60-150 seconds
Peak Temperature (T <sub>P</sub> )	240°C +0°C/-5°C	260°C +0°C/-5°C
Time within 5°C of Actual Peak Temperature (t <sub>P</sub> )	10-30 seconds	20-40 seconds
Ramp-Down Rate	6°C/second max	
Time 25°C to Peak Temperature	6 minutes max	8 minutes max

Figure 2. Recommended Soldering Profile

# TYPICAL PERFORMANCE CHARACTERISTICS

( $V_s = 5\text{ V}$  for all graphs, unless otherwise noted.)

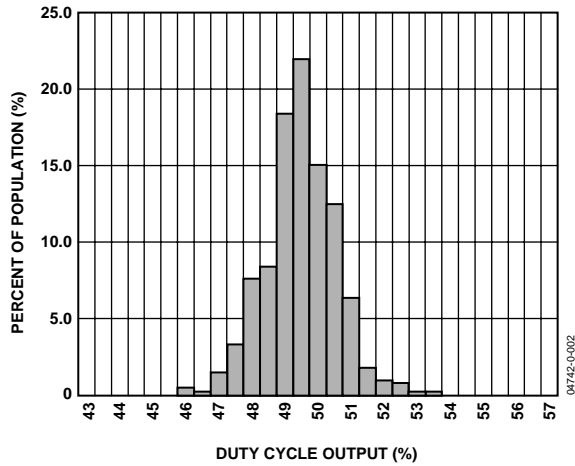

Figure 3. X Axis Zero g Bias Deviation from Ideal at 25°C

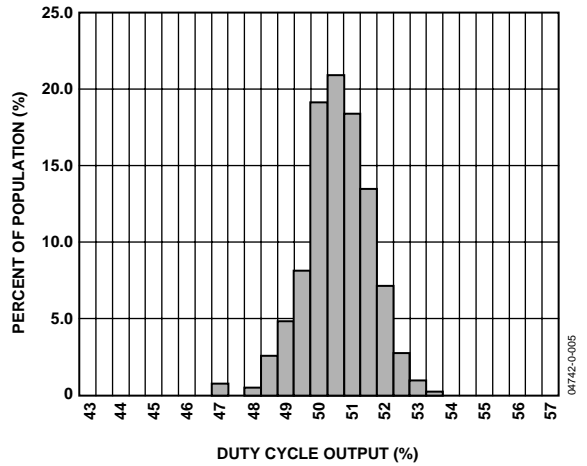

Figure 6. Y Axis Zero g Bias Deviation from Ideal at 25°C

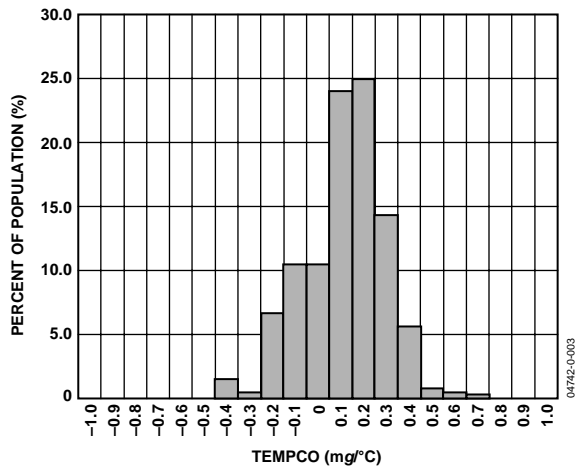

Figure 4. X Axis Zero g Bias Tempco

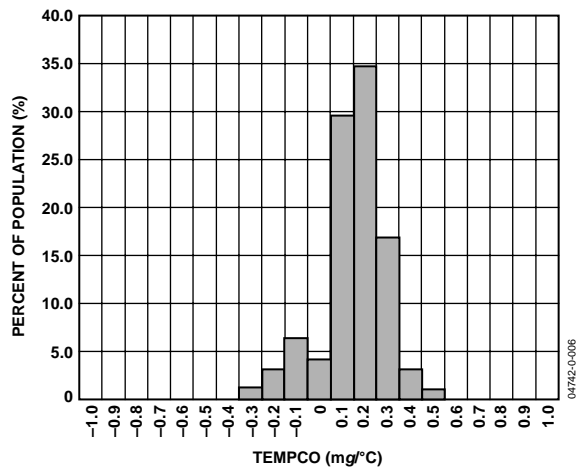

Figure 7. Y Axis Zero g Bias Tempco

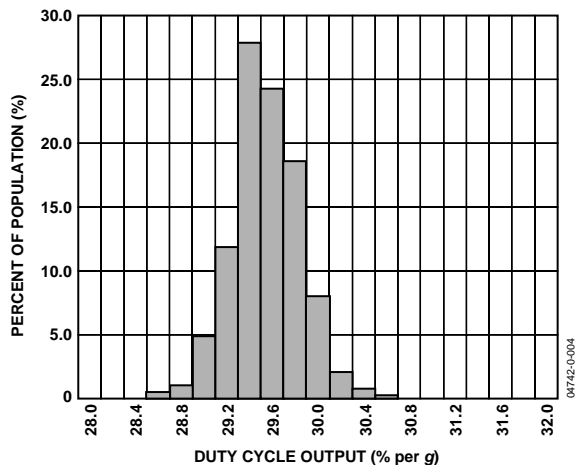

Figure 5. X Axis Sensitivity at 25°C

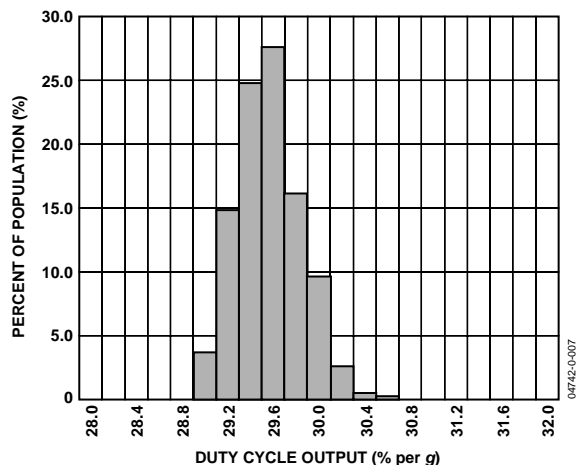

Figure 8. Y Axis Sensitivity at 25°C

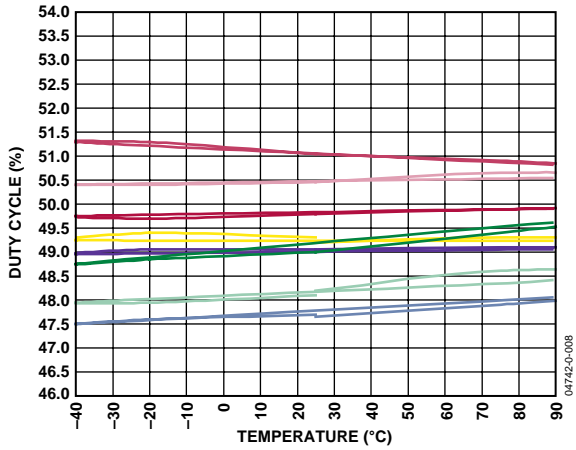

Figure 9. Zero g Bias vs. Temperature – Parts Soldered to PCB

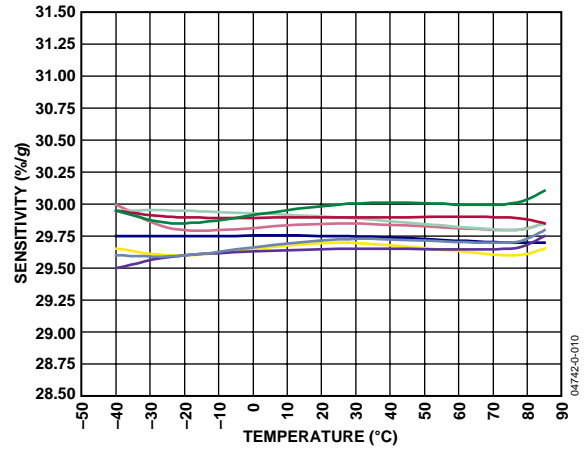

Figure 12. Sensitivity vs. Temperature – Parts Soldered to PCB

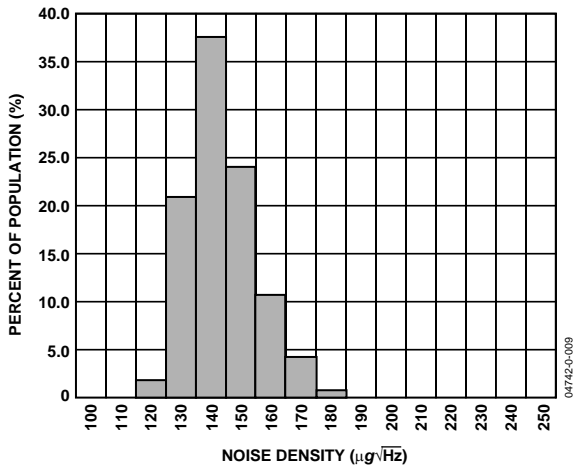

Figure 10. X Axis Noise Density at 25°C

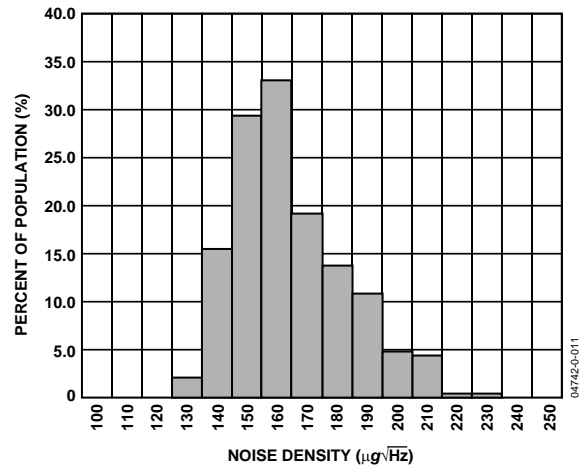

Figure 13. Y Axis Noise Density at 25°C

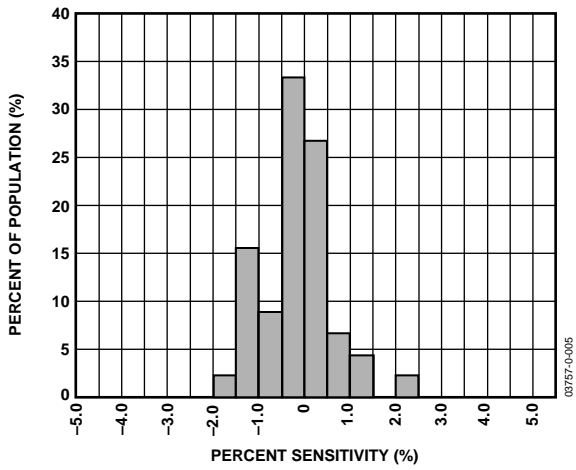

Figure 11. Z vs. X Cross-Axis Sensitivity

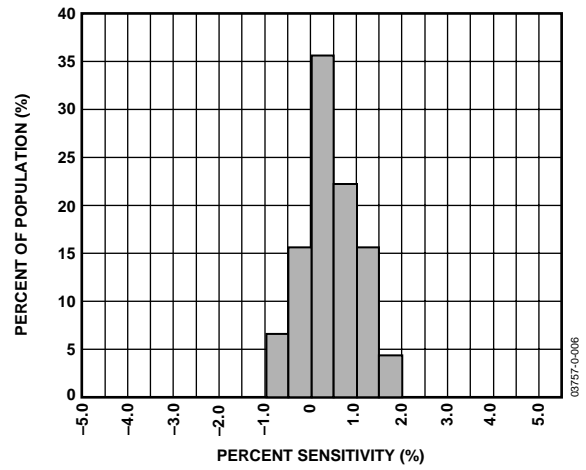

Figure 14. Z vs. Y Cross-Axis Sensitivity

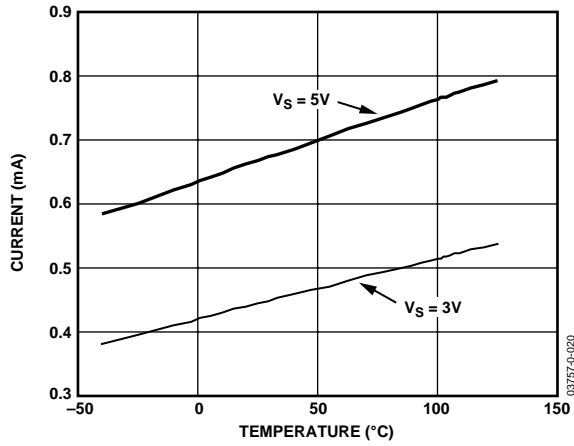

Figure 15. Supply Current vs. Temperature

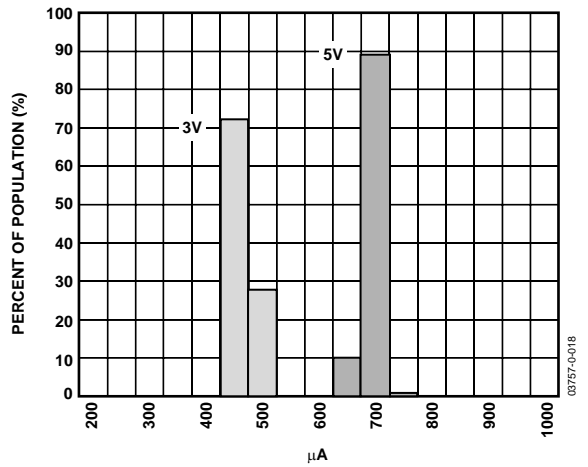

Figure 18. Supply Current at 25°C

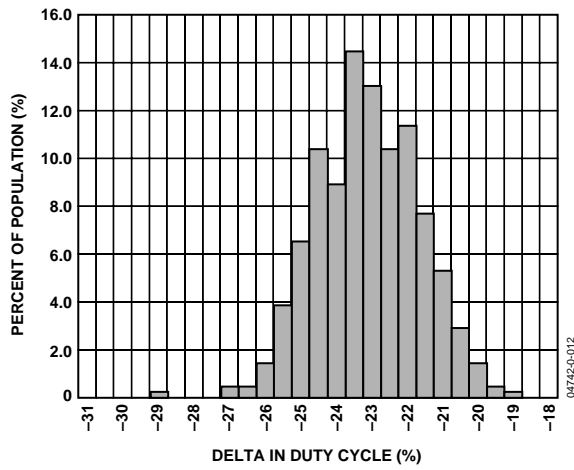

Figure 16. X Axis Self Test Response at 25°C

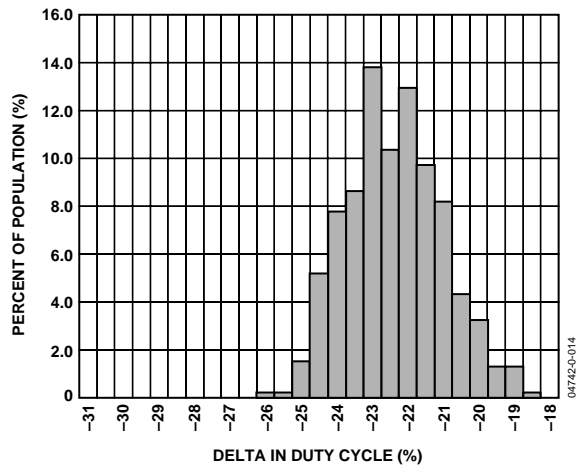

Figure 19. Y Axis Self Test Response at 25°C

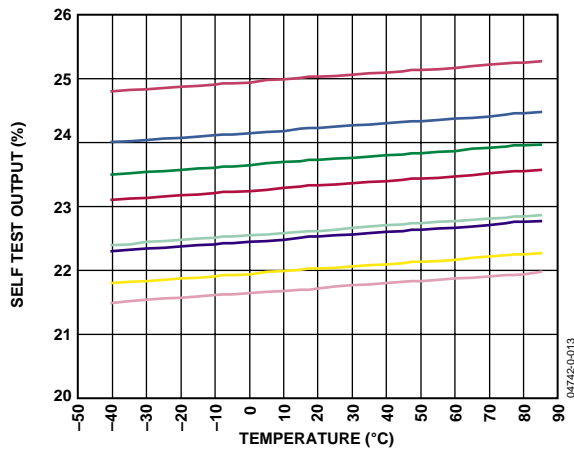

Figure 17. Self Test Response vs. Temperature

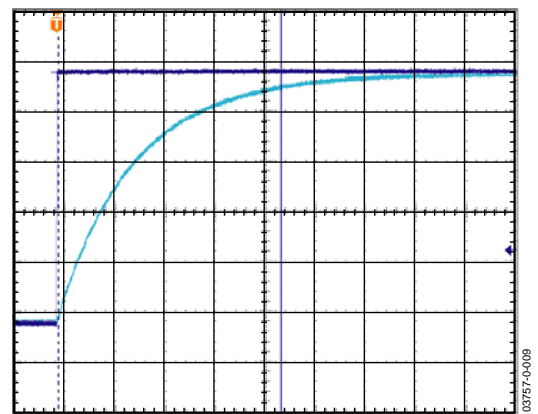

Figure 20. Turn-On Time –  $C_X, C_Y = 0.1 \mu F$ , Time Scale = 2 ms/div

## THEORY OF OPERATION

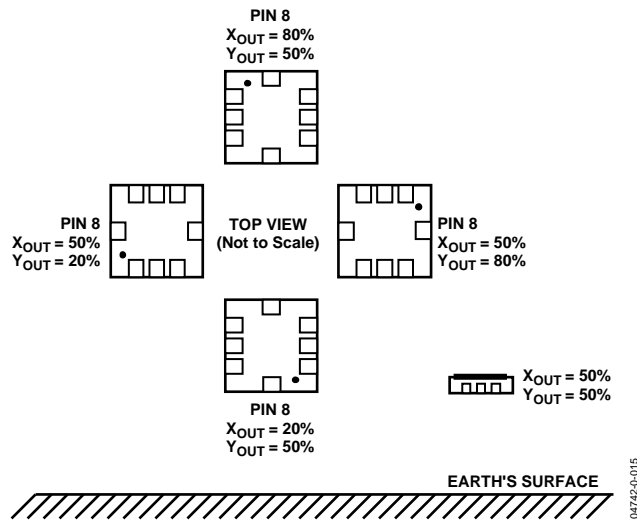

Figure 21. Output Response vs. Orientation

The ADXL213 is a complete dual axis acceleration measurement system on a single monolithic IC. It contains a polysilicon surface-micromachined sensor and signal conditioning circuitry to implement an open-loop acceleration measurement architecture. The output signals are duty cycle modulated digital signals proportional to acceleration. The ADXL213 is capable of measuring both positive and negative accelerations to  $\pm 1.2 g$ . The accelerometer can measure static acceleration forces such as gravity, allowing the ADXL213 to be used as a tilt sensor.

The sensor is a surface-micromachined polysilicon structure built on top of the silicon wafer. Polysilicon springs suspend the structure over the surface of the wafer and provide a resistance against acceleration forces. Deflection of the structure is measured using a differential capacitor that consists of independent fixed plates and plates attached to the moving mass. The fixed plates are driven by  $180^\circ$  out-of-phase square waves. Acceleration deflects the beam and unbalances the differential capacitor, resulting in an output square wave whose amplitude is proportional to acceleration. Phase sensitive demodulation techniques are then used to rectify the signal and determine the direction of the acceleration.

The output of the demodulator is amplified and brought off-chip through a  $32 k\Omega$  resistor. At this point, the user can set the signal bandwidth of the device by adding a capacitor. This filtering improves measurement resolution and helps prevent aliasing.

After being low-pass filtered, the duty cycle modulator converts the analog signals to duty cycle modulated outputs that can be read by a counter. A single resistor ( $R_{SET}$ ) sets the period for a complete cycle. A  $0 g$  acceleration produces a 50% nominal duty cycle. The acceleration can be determined by measuring the length of the positive pulse width ( $t_1$ ) and the period ( $t_2$ ). The nominal transfer function of the ADXL213 is

$$Acceleration = ((t_1/t_2) - Zero\ g\ Bias)/Sensitivity$$

Where in the case of the ADXL213

$$Zero\ g\ Bias = 50\% \text{ nominal}$$

$$Sensitivity = 30\%/g \text{ nominal}$$

$$t_2 = R_{SET}/125\ M\Omega$$

### PERFORMANCE

Rather than using additional temperature compensation circuitry, innovative design techniques have been used to ensure that high performance is built in. As a result, there is essentially no quantization error or nonmonotonic behavior, and temperature hysteresis is very low (typically less than 10 mg over the  $-40^\circ C$  to  $+85^\circ C$  temperature range).

Figure 9 shows the zero g output performance of eight parts (X and Y axis) over a  $-40^\circ C$  to  $+85^\circ C$  temperature range.

Figure 12 demonstrates the typical sensitivity shift over temperature for  $V_s = 5 V$ . Sensitivity stability is optimized for  $V_s = 5 V$ , but is still very good over the specified range; it is typically better than  $\pm 2\%$  over temperature at  $V_s = 3 V$ .



## APPLICATIONS

### POWER SUPPLY DECOUPLING

For most applications, a single 0.1 μF capacitor, C<sub>DC</sub>, adequately decouples the accelerometer from noise on the power supply. However, in some cases, particularly where noise is present at the 140 kHz internal clock frequency (or any harmonic thereof), noise on the supply may cause interference on the ADXL213's output. If additional decoupling is needed, a 100 Ω (or smaller) resistor or ferrite beads may be inserted in the supply line of the ADXL213. Additionally, a larger bulk bypass capacitor (in the range of 1 μF to 22 μF) may be added in parallel to C<sub>DC</sub>.

### SETTING THE BANDWIDTH USING C<sub>X</sub> AND C<sub>Y</sub>

The ADXL213 has provisions for bandlimiting the X<sub>OUT</sub> and Y<sub>OUT</sub> pins. Capacitors must be added at these pins to implement low-pass filtering for antialiasing and noise reduction. The equation for the -3 dB bandwidth is

$$F_{-3\text{dB}} = 1 / (2\pi(32\text{ k}\Omega) \times C_{(X,Y)})$$

or more simply,

$$F_{-3\text{dB}} = 5\ \mu\text{F} / C_{(X,Y)}$$

The tolerance of the internal resistor (R<sub>FILT</sub>) can vary typically as much as ±25% of its nominal value (32 kΩ); thus, the bandwidth varies accordingly. A minimum capacitance of 2000 pF for C<sub>X</sub> and C<sub>Y</sub> is required in all cases.

**Table 4. Filter Capacitor Selection, C<sub>X</sub> and C<sub>Y</sub>**

Bandwidth (Hz)	Capacitor (μF)
1	4.7
10	0.47
50	0.10
100	0.05
200	0.027
500	0.01

### SELF TEST

The ST pin controls the self-test feature. When this pin is set to V<sub>S</sub>, an electrostatic force is exerted on the beam of the accelerometer. The resulting movement of the beam allows the user to test if the accelerometer is functional. The typical change in output is 750 mg (corresponding to 23%). This pin may be left open circuit, or may be connected to common in normal use.

The ST pin should never be exposed to voltages greater than V<sub>S</sub> + 0.3 V. If the system design is such that this condition cannot be guaranteed (i.e., multiple supply voltages present), a low V<sub>F</sub> clamping diode between ST and V<sub>S</sub> is recommended.

### DESIGN TRADE-OFFS FOR SELECTING FILTER CHARACTERISTICS: THE NOISE/BW TRADE-OFF

The accelerometer bandwidth selected ultimately determines the measurement resolution (smallest detectable acceleration). Filtering can be used to lower the noise floor, which improves the resolution of the accelerometer. Resolution is dependent on the analog filter bandwidth at X<sub>FILT</sub> and Y<sub>FILT</sub>.

The output of the ADXL213 has a typical bandwidth of 2.5 kHz. The user must filter the signal at this point to limit aliasing errors. The analog bandwidth must be no more than one-fifth the PWM frequency to minimize aliasing. The analog bandwidth may be further decreased to reduce noise and improve resolution.

The ADXL213 noise has the characteristics of white Gaussian noise, which contributes equally at all frequencies and is described in terms of μg/√Hz (i.e., the noise is proportional to the square root of the accelerometer's bandwidth). The user should limit bandwidth to the lowest frequency needed by the application in order to maximize the resolution and dynamic range of the accelerometer.

With the single pole roll-off characteristic, the typical noise of the ADXL213 is determined by

$$rmsNoise = (160\ \mu\text{g} / \sqrt{\text{Hz}}) \times (\sqrt{BW \times 1.6})$$

At 100 Hz the noise is

$$rmsNoise = (160\ \mu\text{g} / \sqrt{\text{Hz}}) \times (\sqrt{100 \times 1.6}) = 2\ \text{mg}$$

Often, the peak value of the noise is desired. Peak-to-peak noise can only be estimated by statistical methods. Table 5 is useful for estimating the probabilities of exceeding various peak values, given the rms value.

**Table 5. Estimation of Peak-to-Peak Noise**

Peak-to-Peak Value	% of Time that Noise Will Exceed Nominal Peak-to-Peak Value
2 × RMS	32
4 × RMS	4.6
6 × RMS	0.27
8 × RMS	0.006

# ADXL213

Peak-to-peak noise values give the best estimate of the uncertainty in a single measurement. Table 6 gives the typical noise output of the ADXL213 for various  $C_X$  and  $C_Y$  values.

**Table 6. Filter Capacitor Selection ( $C_X$ ,  $C_Y$ )**

Bandwidth(Hz)	$C_X$ , $C_Y$ ( $\mu$ F)	RMS Noise (mg)	Peak-to-Peak Noise Estimate (mg)
10	0.47	0.64	3.8
50	0.1	1.4	8.6
100	0.047	2	12
500	0.01	4.5	27.2

## USING THE ADXL213 WITH OPERATING VOLTAGES OTHER THAN 5 V

The ADXL213 is tested and specified at  $V_S = 5$  V; however, it can be powered with  $V_S$  as low as 3 V or as high as 6 V. Some performance parameters will change as the supply voltage is varied.

The ADXL213 output varies proportionally to supply voltage. At  $V_S = 3$  V, the output sensitivity is typically 28%/g.

The zero g bias output is ratiometric, so the zero g output is nominally equal to 50% at all supply voltages.

The output noise also varies with supply voltage. At  $V_S = 3$  V, the noise density is typically  $200 \mu\text{g}/\sqrt{\text{Hz}}$ .

Self-test response in g is roughly proportional to the square of the supply voltage. So at  $V_S = 3$  V, the self-test response is equivalent to approximately 270 mg (typical), or 8%.

The supply current decreases as the supply voltage decreases. Typical current consumption at  $V_{DD} = 3$  V is 450  $\mu$ A.

## USING THE ADXL213 AS A DUAL-AXIS TILT SENSOR

One of the most popular applications of the ADXL213 is tilt measurement. An accelerometer uses the force of gravity as an input vector to determine the orientation of an object in space.

An accelerometer is most sensitive to tilt when its sensitive axis is perpendicular to the force of gravity, i.e., parallel to the earth's surface. At this orientation, its sensitivity to changes in tilt is highest. When the accelerometer is oriented on axis to gravity, i.e., near its +1 g or -1 g reading, the change in output acceleration per degree of tilt is negligible. When the accelerometer is perpendicular to gravity, its output changes nearly 17.5 mg per degree of tilt. At 45°, its output changes at only 12.2 mg per degree and resolution declines.

### **Dual-Axis Tilt Sensor: Converting Acceleration to Tilt**

When the accelerometer is oriented so both its X and Y axes are parallel to the earth's surface, it can be used as a 2-axis tilt sensor with a roll axis and a pitch axis. Once the output signal from the accelerometer has been converted to an acceleration that varies between -1 g and +1 g, the output tilt in degrees is calculated as follows:

$$PITCH = ASIN(A_X/1 \text{ g})$$

$$ROLL = ASIN(A_Y/1 \text{ g})$$

Be sure to account for overranges. It is possible for the accelerometers to output a signal greater than  $\pm 1$  g due to vibration, shock, or other accelerations.

## PIN CONFIGURATIONS AND FUNCTIONAL DESCRIPTIONS

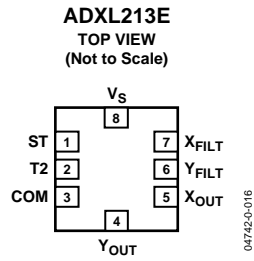

Figure 22. ADXL213 8-Lead CLCC

Table 7. ADXL213 8-Lead CLCC Pin Function Descriptions

Pin No.	Mnemonic	Description
1	ST	Self Test
2	T2	R <sub>SET</sub> Resistor to Common
3	COM	Common
4	Y <sub>OUT</sub>	Y Channel Output
5	X <sub>OUT</sub>	X Channel Output
6	Y <sub>FILT</sub>	Y Channel Filter Pin
7	X <sub>FILT</sub>	X Channel Filter Pin
8	V <sub>S</sub>	3 V to 6 V

# ADXL213

## OUTLINE DIMENSIONS

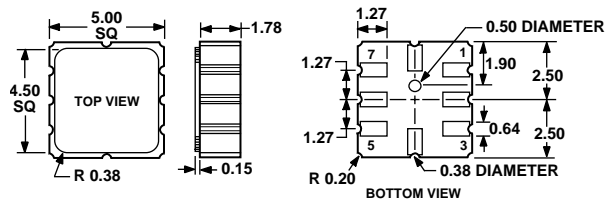

Figure 23. 8-Terminal Ceramic Leadless Chip Carrier [LCC]  
(E-8)

Dimensions shown in millimeters

## ESD CAUTION

ESD (electrostatic discharge) sensitive device. Electrostatic charges as high as 4000 V readily accumulate on the human body and test equipment and can discharge without detection. Although this product features proprietary ESD protection circuitry, permanent damage may occur on devices subjected to high energy electrostatic discharges. Therefore, proper ESD precautions are recommended to avoid performance degradation or loss of functionality.



## ORDERING GUIDE

ADXL213 Products	Number of Axes	Specified Voltage (V)	Temperature Range	Package Description	Package Option
ADXL213AE <sup>1</sup>	1	5	-40°C to +85°C	8-Lead Ceramic Leadless Chip Carrier	E-8
ADXL213AE-REEL <sup>1</sup>	1	5	-40°C to +85°C	8-Lead Ceramic Leadless Chip Carrier	E-8
ADXL213EB				Evaluation Board	

<sup>1</sup> Lead Finish—Gold over Nickel over Tungsten.